

# THERMORY®

THERMORY® cladding products undergo an intense thermal modification process that makes the wood more durable and stable in outdoor conditions while also emphasizing its warm golden-brown color and characteristic grain pattern. Using the correct installation and maintenance techniques will result in beautiful, long-lasting cladding.

These installation guidelines are purely informative and based on the best knowledge currently available, and they should be used accordingly. We advise you to follow your country's regulations where they conflict with the general recommendations found in this guide.

## Installation Guide

1. Storage
2. Types of cladding
  - 2.1 Horizontal cladding
  - 2.2 Vertical cladding
  - 2.3 Versatile cladding for both vertical and horizontal installation
3. Building a substructure and avoiding moisture damage
4. Correct fastening with staples, nails or screws

## Cladding Boards

5. Installation systems with hidden fixings
  - 5.1 PaCS® (Press and Click System)
  - 5.2 B1-1 clips
  - 5.3 T-4 and T-6 clips
  - 5.4 Dekora clips
6. Corner designs
7. Installing pre-finished Thermory cladding
8. Surface maintenance



Benchmark by Thermory thermo-radiata pine cladding. (C3)  
Jack's Point Family Home in New Zealand  
Designed by Ben Hudson architects.  
Photo by Sarah Rowlands

# 1. Storage

Whenever possible, Thermory cladding boards should be stored indoors. The cladding should also be kept away from direct sunlight as UV rays will cause the color of the boards to fade.

If stored outside, the boards should be elevated at least 150 mm from the ground, stacked evenly, and protected with a waterproof, light-impermeable cover. Leave the ends of the cover unfastened to allow for ventilation while still preventing moisture damage. Thermory cladding should never be left in the rain or exposed to excess moisture while in its original packaging, as it will not be able to dry properly when tightly packaged.

When restacking painted cladding products at the work site, do not remove the protective foil from between the visible sides of the cladding, as the boards should not be stacked with the painted surfaces touching each other without a foil layer in between.

Be careful when restacking brushed products, as the separating sticks may leave marks if placed against the visible sides of the boards. Stack the brushed sides facing each other, placing the sticks between the back sides.

Cladding products for indoor use must be stored in a heated indoor space for a few weeks prior to installation.

## IMPORTANT!



Do not get dirt or grease on the products during transport or installation.



Handle Thermory boards with care. The tongue-and-groove sections of boards may be fragile.



Allow for 10 percent wastage when purchasing.



Check the boards thoroughly for possible transport-related damage prior to installation, and never install defective boards. **ONCE INSTALLED, PRODUCTS ARE DEEMED TO HAVE BEEN ACCEPTED IN TERMS OF QUALITY.**

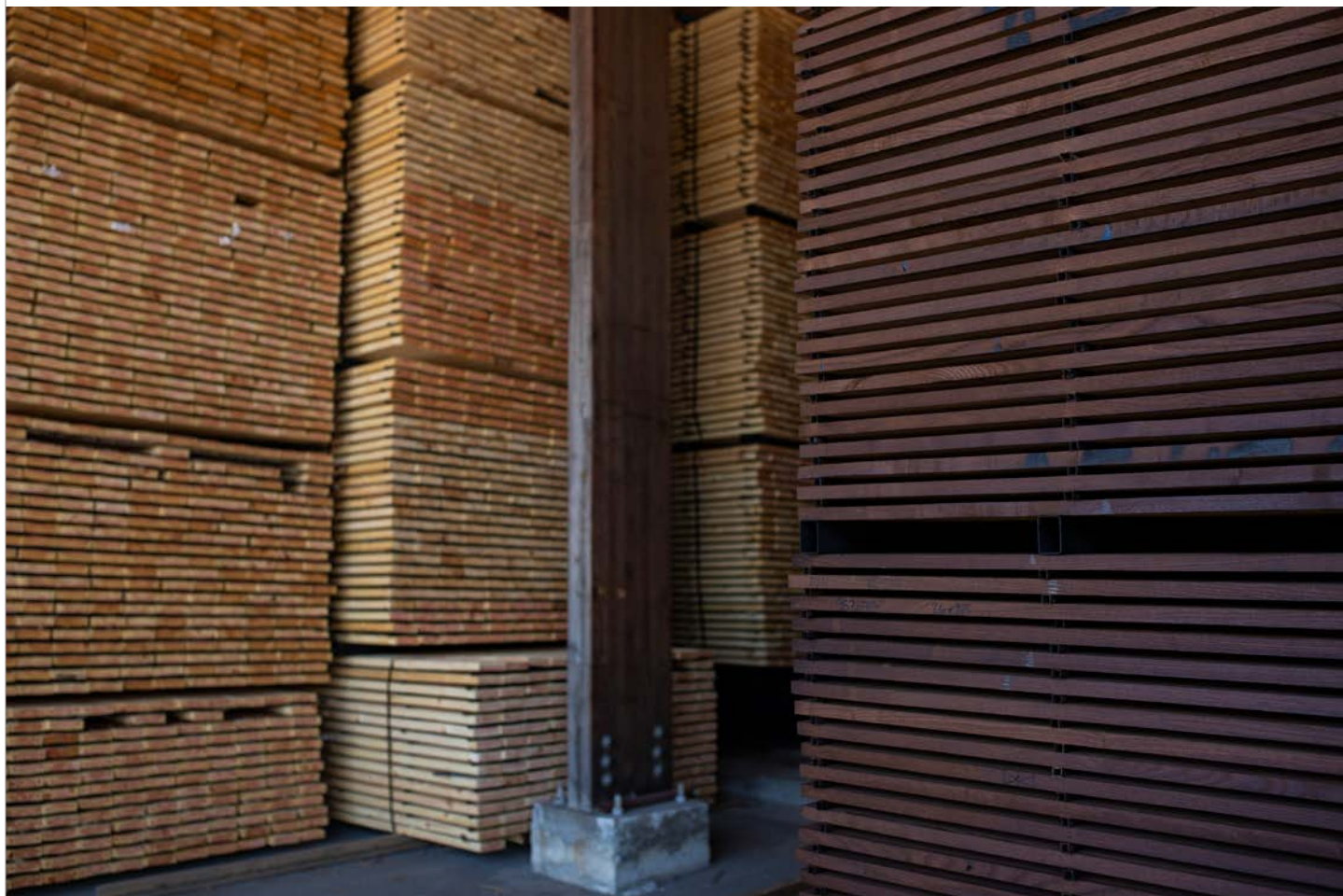

# 2. Types of cladding

## 2.1 HORIZONTAL CLADDING

**THERMORY CLADDING PROFILES FOR HORIZONTAL INSTALLATION:**  
C2R4, C6, C7J, C7T, C8D, C9, C11, C23J,

C44J, C92, G-C77J, S1, S2-BBME, S2-BBMS, S2-E

Here are some basic horizontal installation options:

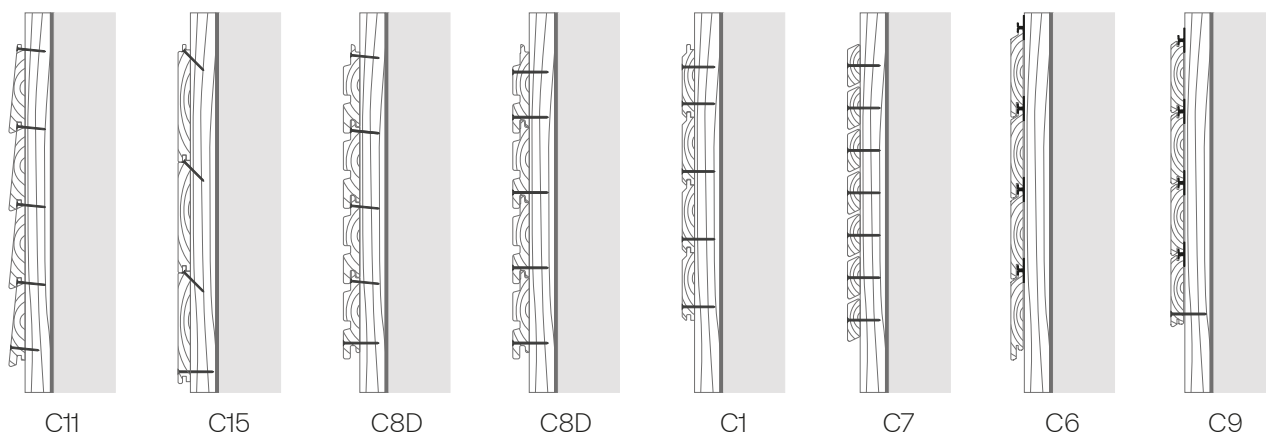

Benchmark by Thermory thermo-ash cladding  
New American Home 2020  
Photo by Jeffrey A. Davis Photography

For shiplap profiles, leave an air circulation space of 2-3 mm to allow for swelling of the wooden boards.

Always install shiplap cladding from the lower edge of the wall upwards.

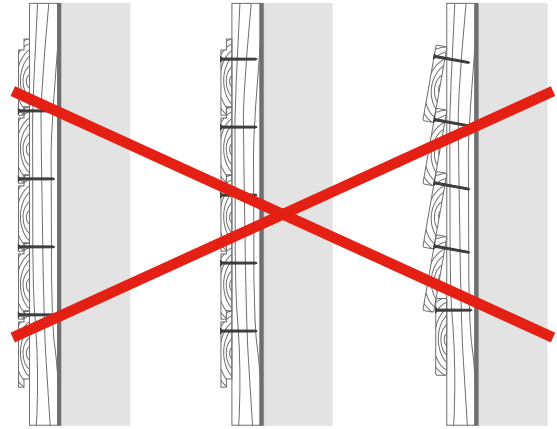

## 2.2 VERTICAL CLADDING

### THERMORY CLADDING PROFILES FOR VERTICAL INSTALLATION: C12, C27, C34, C34-2, CP3, D43, UYS10

Some basic vertical installation options are shown aside:

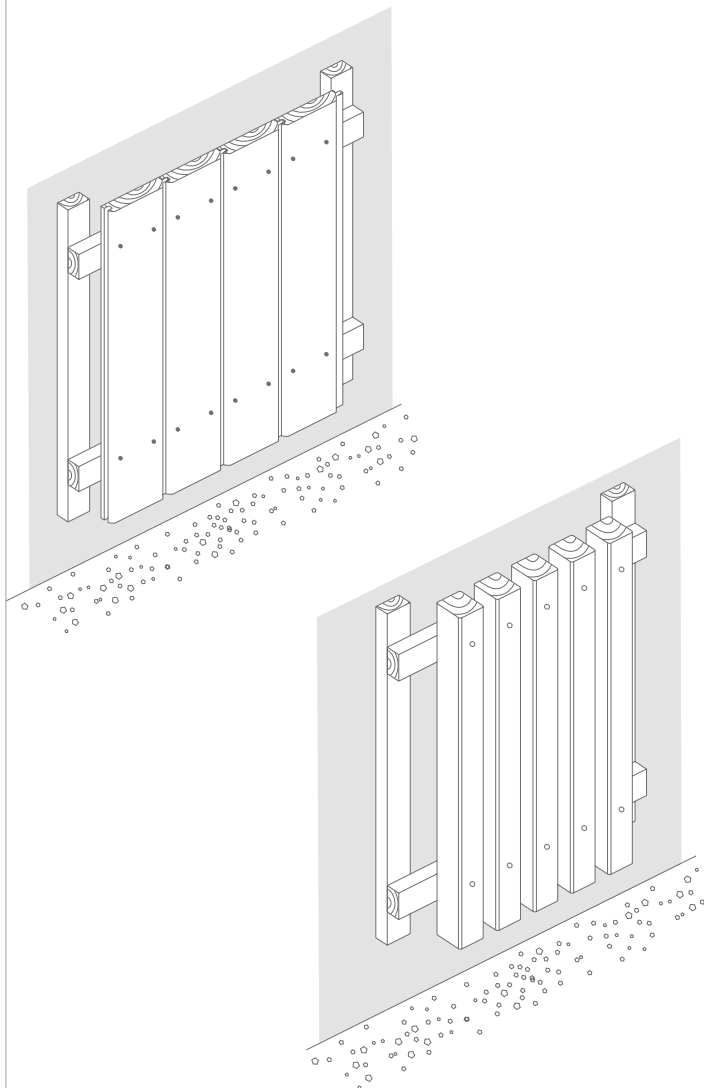

## 2.3 VERSATILE CLADDING FOR BOTH VERTICAL AND HORIZONTAL INSTALLATION

**THERMORY CLADDING PROFILES FOR BOTH VERTICAL AND HORIZONTAL INSTALLATION:** C1, C3, C4, C4J, C7, C8, C15, C16, C19, C20, C24, C25, C26, C30, C32, C42, CAR1, CAR3, CAR8, CAR12

# 3. Building a proper substructure and avoiding moisture damage

When installing Thermory cladding, always use **stainless steel** nails, staples or screws, or Thermory fastening clips. Boards with a tongue and groove should be installed with

the tongues pointing upwards. In vertical applications, the tongues should point in the direction that the wind most commonly blows from.

## END-MATCHING JOINTS

With Thermory's exclusive JEM™ joint, the ends of the cladding boards do not need to rest on battens. This creates less waste, reducing labor costs and shortening the installation time.

Each board must be resting on, and fastened to, a minimum of two battens.

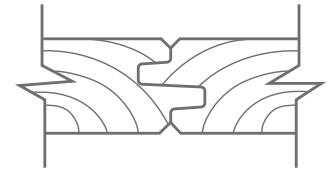

## SUBSTRUCTURE BATTENS

Refer to local building regulations for the correct batten spacing based on wind loads – do not install battens with spaces exceeding 600 mm.

When fixing boards using staples, nails or screws, we recommend using Thermory Benchmark thermo-spruce with a Class 1 biological durability rating for the battens. Battens must be placed no more than 600 mm apart and be at least 25 mm thick in order to create a sufficient gap behind the cladding boards for ventilation.

Fix horizontal cladding boards onto vertical battens, with the ends resting on the battens for boards without end-matching. Joint end-matched boards can be placed with the joints meeting between the battens; this will save both material and time.

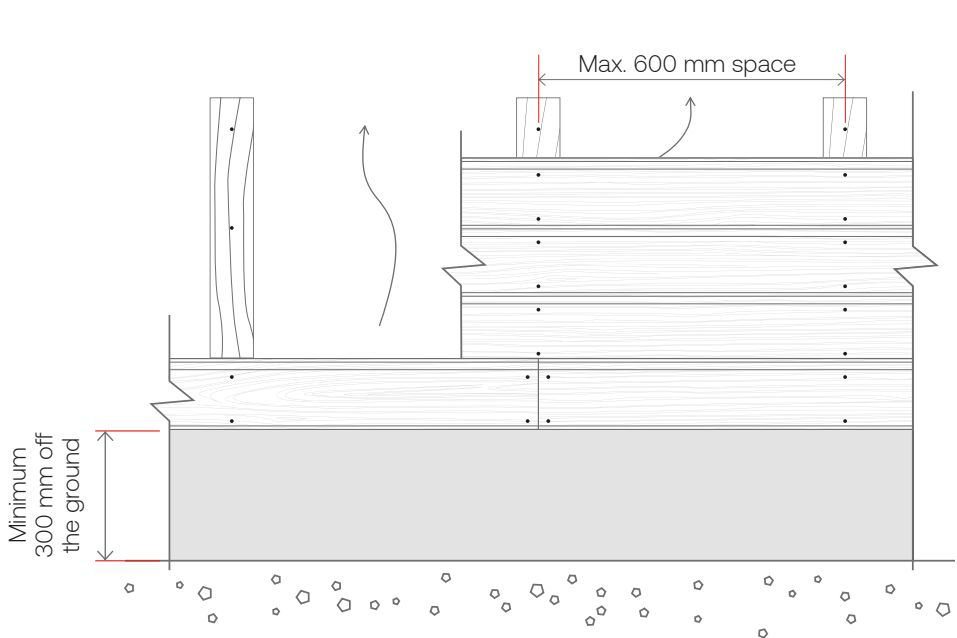
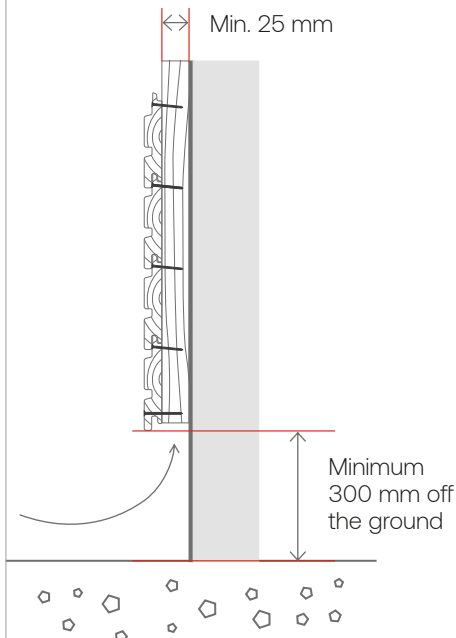

Fix **vertical cladding** onto horizontal battens; the joint ends of the boards must be resting on the battens with standard cladding boards. Joint end-matched boards can be placed with the joints meeting between the battens; this will save both material and time.

In vertical installations, allow for air movement with an additional vertical batten.

In the case of vertical applications with clip systems, make sure to fix at least one end of each board with a stainless-steel screw to prevent lengthwise movement of the board.

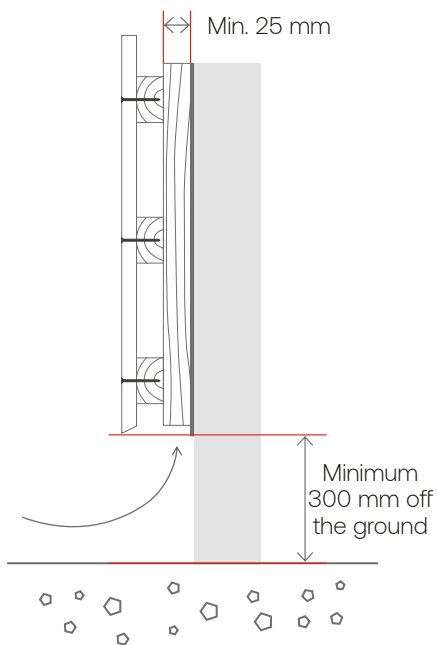
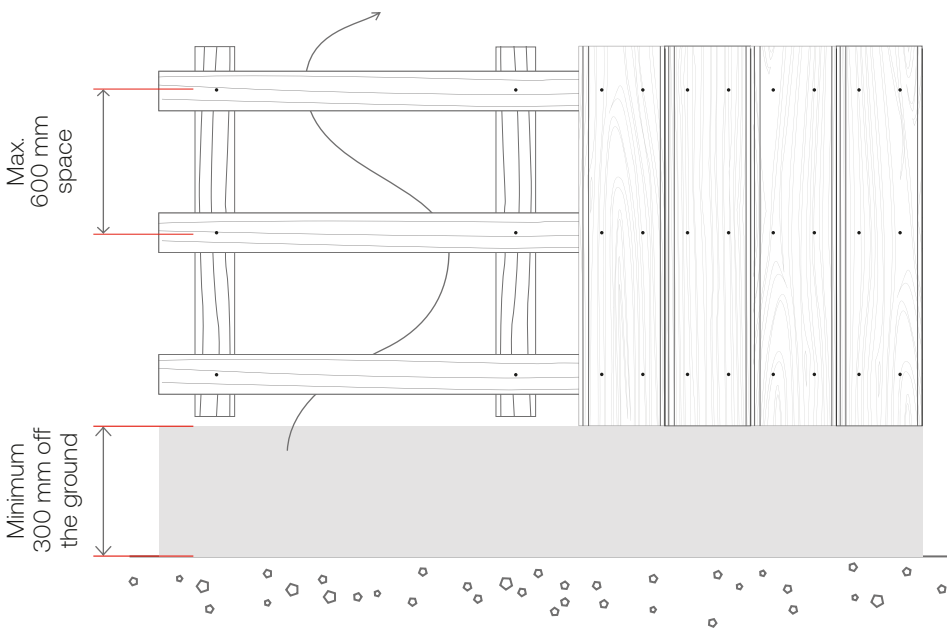

## AVOIDING MOISTURE DAMAGE

It is necessary to leave a gap of at least 300 mm between the ground and the cladding, and it is also important to prevent any grass growing nearby from coming into contact with the cladding.

Leave an air gap of at least 25 mm behind the boards to prevent moisture damage by allowing for vertical air flow. For vertical cladding installed with horizontal battens, install an additional set of vertical battens behind the horizontal ones to ensure sufficient air flow. The ventilation space behind the cladding boards must also remain open from both above and below to ensure air circulation.

When installing Thermory cladding boards without end-matching (with no JEM joint), leave a space of approximately 3 mm between the ends of the boards. This will allow for air circulation and prevent swelling caused by trapped moisture.

Do not position end joints adjacent to each other. Where possible, distribute the end joints evenly across the façade for a uniform end result.

For reversible C4 profiles, where possible we recommend installing thermo-spruce with the heartwood hidden from direct sunlight.

## SPRUCE WITH THE HEARTWOOD FACING THE BUILDING

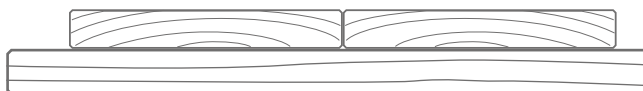

# 4. Correct fastening with staples, nails or screws

## THERMORY CLADDING PROFILES FOR FASTENING WITH SCREWS ONLY:

● BENCHMARK THERMO-ASH

Hidden fixing profiles: C25, C54

Visible fixing profiles: C4, C7, C12, C20, CAR1, CAR8, CAR12, D4, D43

For Thermory thermo-ash cladding, pilot holes should be predrilled. The pilot holes should be equal in diameter to the screw's nominal diameter to allow for any necessary board movement and prevent shear stress on the screws. Some self-tapping screw brands, such as SOLIDA1, may occasionally be suitable for use without predrilling, but if using these with thermo-ash cladding you should try them out prior to installation and use at your own risk.

## THERMORY CLADDING PROFILES FOR FASTENING WITH SCREWS, STAPLES OR NAILS:

● BENCHMARK THERMO-PINE, THERMO-SPRUCE AND THERMO-RADIATA PINE

Hidden fixing profiles: C8, C11, C11-S, C15, C25, C26, C27, C30, C34, C34-2, C54

Visible fixing profiles: C1, C2-R4, C3, C4, C7, C7-15R1.5, C8, C12, C16, C19, C20, C24, C27, C32, C42, CAR3, CAR8, CAR10, D4, UYS10

Thermory thermo-pine, thermo-spruce and thermo-radiata pine cladding can be fixed with self-tapping screws. Be sure to set the power drill's clutch to the medium setting. The head of the screw should sit flush with the surface of the board when fixed.

Fasteners such as screws, nails and staples must not penetrate the wood too deeply – they should be roughly level with the surface to reduce the risk of water absorption.

For indoor applications, Dyckert nails, or finishing nails, may be used with the head sunk 1 mm into the timber.

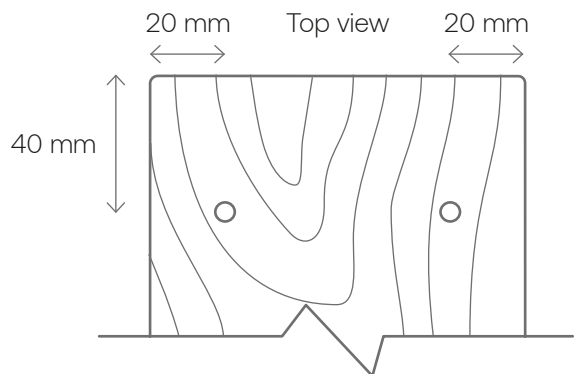
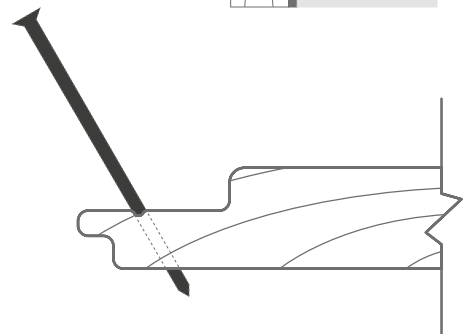
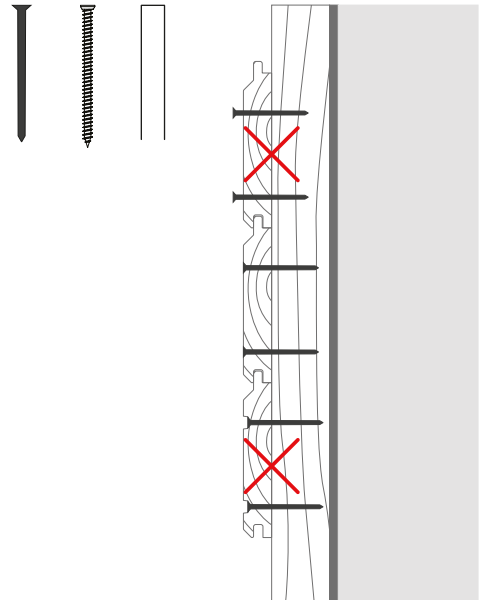

In some profiles, a small line in the tongue section indicates where staples, screws or nails should be placed in order to fix a board through the tongue in such a way that the fastening will be hidden by the groove of the next board.

To avoid the risk of the timber splitting when drilling and fastening close to board ends and edges, leave a distance of no less than 20 mm from the edge and 40 mm from the end of the board. Sometimes an additional batten must be used to allow for a space of 40mm from the end of the board.

The length of screws or nails should be at least 2.5 times the thickness of the board at its thickest point.

We suggest to fix the boards over 140 mm wide with two screws, one on each edge of the board.

The above fastening suggestions are the most suitable methods based on Thermory's knowledge. Local building regulations may require other dimensions or fixing types. Always follow the requirements set out in local building codes.

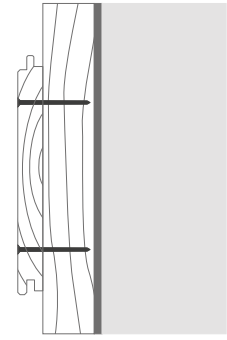
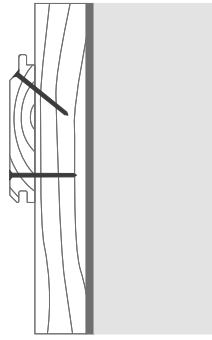

WATCH THE  
INSTALLATION  
VIDEOS



C24 PROFILE:



C15 PROFILE:



C34 MIX&MATCH  
PROFILE:



## 5. Installation systems with hidden fixings

When fixing boards with clip systems, consider fixing at least one end of each board with a stainless-steel screw or nail to prevent lengthwise movement of the boards.

### 5.1 PaCS® (PRESS AND CLICK SYSTEM)



The PaCS product range combines high-quality Thermory thermally modified wood with the unique Grad® installation system. PaCS is a hidden fastening solution that is designed for quick and easy installation. Thermory PaCS consists of specially profiled Thermory boards with one or two grooves on the underside to fit with either the Grad clips or aluminum rails

with pre-mounted Grad clips. As a result, there are no visible screw heads – the boards can simply be pressed and clicked into place.

The quickest and easiest cladding fastening solution is Thermory PaCS CLAD battens with PaCS Alu Rails with pre-mounted Grad clips.

In the case of façades with open spaces between the boards, PaCS Alu Rail Start and PaCS Alu Rail PR56 come with an option to remove and replace any board at any time while keeping the existing boards and clips reusable.



The boards simply click into place when depressed.

Special keys for board removal.

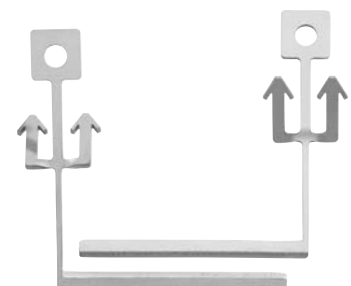



## PaCS BATTENS WITH FACTORY-POSITIONED CLIPS

**PaCS CLAD** is a thermo-pine CLAD with factory-positioned Grad clips for 52, 65, 72, 150 and 186 mm wide Thermory boards with grooves on the undersides. Other board widths and gaps are available on request.

**PaCS CLAD SIZE:**  
26 x 67 x 2000 mm

**BOARD HEIGHT FROM SUBSTRUCTURE:**  
26 + 5 = 31 mm

**REQUIRED NUMBER OF PaCS CLAD:**  
1 pc per square meter

**PCS. PER PALLET:** 196



**PaCS Alu Rail Start** is an aluminum rail with factory-positioned Grad clips for 52, 65, 72, 118, 138 and 150 mm wide Thermory boards with grooves on the undersides. The clips are replaceable and can be removed with a special key.

**PaCS ALU RAIL START SIZE:**  
**ALU RAIL START 118** 12 x 47 x 1984 mm  
**ALU RAIL START 150** 12 x 47 x 1876 mm

**BOARD HEIGHT FROM SUBSTRUCTURE:**  
12 + 6 = 18 mm

**REQUIRED NUMBER OF PaCS ALU RAIL START:**  
1 pc per square meter

Available special keys for board removal.

**RAILS PER PALLET:** 216



**PaCS Alu Rail 56** is an aluminum rail with load-bearing capabilities and factory-positioned Grad clips for 118 mm wide Thermory boards with grooves on the undersides. The clips are replaceable and can be removed with a special key.

**PaCS ALU RAIL 56 SIZE:**  
56 x 63,6 x 1984 mm

**BOARD HEIGHT FROM SUBSTRUCTURE:**  
rail 56 mm + clips 6 = 62 mm

**REQUIRED NUMBER OF ALU RAIL 56 JOIST:**  
1 pcs per one square meter

**RAILS PER PALLET:** 108



## CHOOSE YOUR PACS CLAD OR PaCS ALU RAIL BASED ON PROFILE WIDTH:

FIXING SYSTEM PRODUCT NAME			CLADDING BOARD WIDTH, MM	PROFILE WITH GRAD GROOVES	PRE-MOUNTED GRAD SINGLE CLIPS PER CLAD OR ALU RAIL	BOARDS PER BATTEN	BOARD STEP, MM
PaCS CLAD	PaCS ALU RAIL START	PaCS ALU RAIL 56					
CLAD52	Alu Rail Start 52		42	C4J	35	35	57
			52	C4J, C7J	35	35	57
CLAD65	Alu Rail Start 65		65	C4J, C7J	28	28	71.4
			134	C4J, C44J	28	14	142.8
			138	G-C7J, G-C77J	28	14	142.8
CLAD65-0	Alu Rail Start 65-0		65	C7J	31	31	64.5
CLAD72	Alu Rail Start 72		72	C7J	25	25	80
	Alu Rail Start 118	Alu Rail 56	118	D45J	32	16	124
CLAD150	Alu Rail Start 150		150	C23J	28 (Alu Rail 26)	14 (Alu Rail 13)	144
CLAD185*			186	C23J	26	13	178

\* Pre-mounted Grad clips on plywood. Contact our sales team info@thermory.com for product specifications.

## PaCS CLAD AND PaCS ALU RAIL INSTALLATION

1. Fix PaCS CLAD or PaCS Alu Rails to the substructure or wall. Leave a distance of 600 mm between battens, ensuring all rows of clips are in perfect alignment.
2. Install the boards by simply pressing and clicking them into place!

**PLEASE NOTE:** PaCS Alu Rail Start and PaCS Alu Rail PR56 cannot be joined together lengthwise by simply placing one rail in direct contact with another! A profile-specific top link spacer must be used to maintain the correct distance between clips from one rail to the next!



Benchmark by Thermory thermo-pine cladding C7J, PaCS CLAD fixing



Benchmark by Thermory thermo-radiata pine cladding C4J, PaCS Alu Rail Start fixing

PaCS Alu Rail Start must be screwed to the substructure every 400 mm. Always ensure that all rows of clips are in perfect alignment before fixing PaCS CLAD or PaCS Alu Rail to the wall substructure.

In the case of vertically installed boards, make sure to fix the lowest board on every row with at least one screw or nail to prevent the boards from sliding down when using a hidden clip fixing system.



Thermory TopLink spacers



WATCH THE HORIZONTAL CLADDING INSTALLATION VIDEOS WITH PaCS



C7J PROFILE:



C23J PROFILE:



## PaCS FIXINGS FOR MOUNTING ON SITE:

**PaCS Strip Clip** is a six-clip strip that fixes three boards sideways onto one batten. These strips must be connected together and fixed to the batten, and the cladding boards can then be easily snapped onto the clips.

**THERMORY PROFILE FOR FASTENING WITH PACS STRIP CLIP:**

D45J, 118 mm width

**STRIP SIZE:**

5 x 63 x 372 mm

**ELEVATION FROM SUBSTRUCTURE:**

5 mm

**ESTIMATED NUMBER OF PaCS STRIP FIXINGS REQUIRED:**

5 strips per m<sup>2</sup> (if the distance between the battens is 600 mm)

**STRIPS PER PACK:** 300, 4 x 25 mm screws included

1. After building a proper substructure, ensure all rows of clips are in perfect alignment.
2. Install 2-3 PaCS Strips on every batten and check that the alignment is correct to enable you to fit the boards.
3. Install the boards by simply pressing and clicking them into place!
4. Now, repeat steps 2 and 3 until your cladding is fully installed. Avoid installing more than the recommended number of PaCS Strips at a time. Installing PaCS Strips to the whole length of a batten at once may result in compromised alignment.

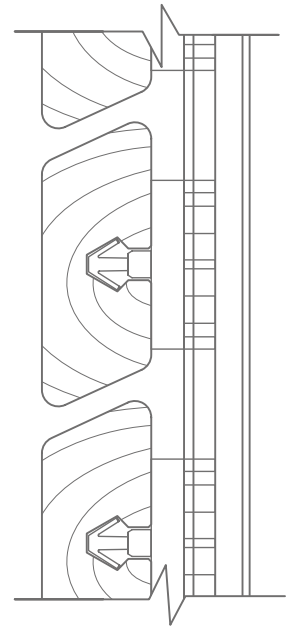

Alu Start 51mm C7J 20x52



**GRAD single clips** are loose clips that can be used on arcs or in situations requiring irregular gaps between clips. Thermory can provide clip-step molds upon request. Grad single clips can be used with all PaCS profiles and fixed based on the specific requirements of the profile.

The tested tearing strength of Grad single clips is 160 kg

The countersink screw size needed for Grad single clips is 4 x 25 mm. Screws must not be overtightened.

**SUITABLE FOR ANY THERMORY PROFILE WITH GROOVES:**

C4J, C5J, C7J, C44J, C23J, G-C7J, G-C77J, D45J

**SINGLE CLIP SIZE:**

5 x 17 x 63 mm

**ELEVATION FROM SUBSTRUCTURE:**

5 mm

**ESTIMATED NUMBER OF GRAD SINGLE CLIP FIXINGS REQUIRED:**

2 clips per running meter

**CLIPS PER PACK:** 900

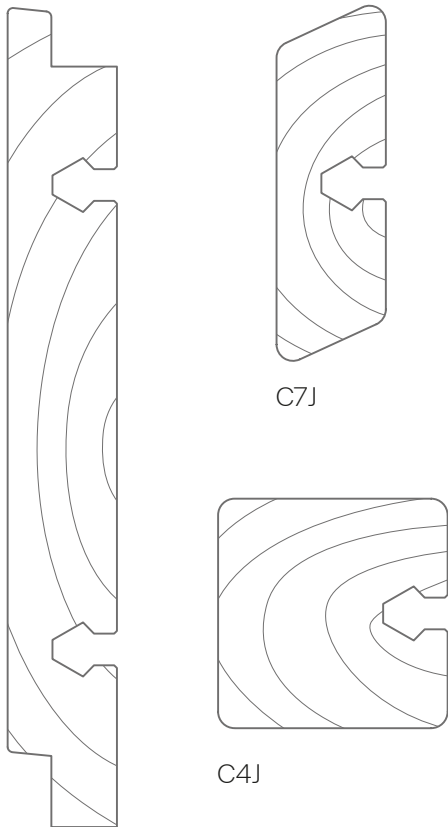

C23J

C7J

C4J



Benchmark thermo-ash C23J



Benchmark thermo-ash C4J



Benchmark thermo-pine C7J

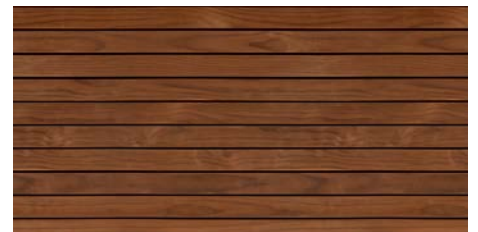

Benchmark thermo-radiata pine C4J

**5.2 B1-1 CLIP**

**THERMORY CLADDING PROFILES FOR B1-1 INSTALLATION: C6, C9**

Thermory stainless steel clip B1-1 creates cladding surface with no visible screws. Use 4 x 40-mm stainless-steel screws to fix the clips to the batten; we recommend 2 screws per clip.

**ESTIMATED NUMBER OF B1-1 CLIP FIXINGS REQUIRED:**

2 clips per running meter of cladding board (if the distance between the battens is 600 mm)

**CLIPS PER WHOLESALE PACKAGE:** 100

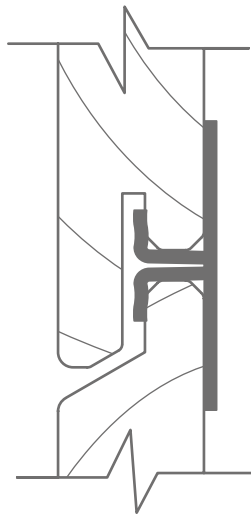

C6

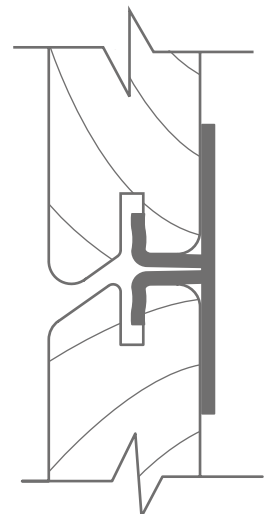

C9

**5.3 T-4 and T-6 CLIPS**

**FOR THERMORY CLADDING PROFILES WITH SIDE GROOVES:**

**T-4 CLIP** for D4 sg2 boards with widths of up to 112 mm

**T-6 CLIP** for C92 and D4 sg2 boards wider than 112 mm

**ESTIMATED NUMBER OF T-4 OR T-6 CLIP FIXINGS REQUIRED:**

2 clips per running meter of cladding board (if the distance between the battens is 600 mm)

**CLIPS PER WHOLESALE PACKAGE:** 500, screws and drill bit included

Thermory black-coated stainless-steel T-4 and T-6 clips both create a cladding surface with no visible screws. The T-4 clip leaves a 4-mm gap between the boards, and T-6 leaves a 6-mm gap. Stainless-steel screws are included with the clips.



T-6 6mm  
T-4 4mm

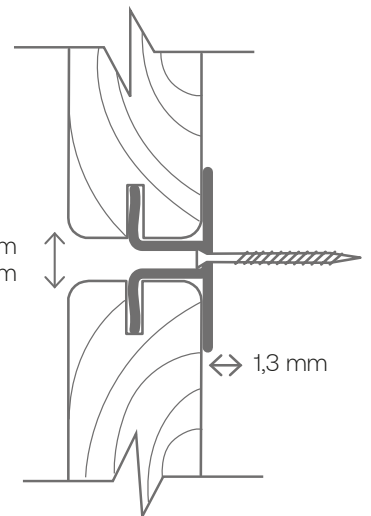

1,3 mm

**5.4 DEKORA CLIPS**

**THERMORY CLADDING PROFILES FOR DEKORA CLIP INSTALLATION: C8D**

The Dekora façade connector guarantees a simple, fast and safe installation process. Fixing with clips allows for some air movement between the boards, ensuring a longer-lasting façade by reducing moisture damage. The C8D profile can be installed with either Dekora clips or hidden staples, screws or nails.

**ESTIMATED NUMBER OF DEKORA CLIP FIXINGS REQUIRED:**

2 clips per running meter of cladding board (if the distance between the battens is 600 mm)

**CLIPS PER WHOLESALE PACKAGE:** 100, 4.5 x 34 mm stainless-steel screws included

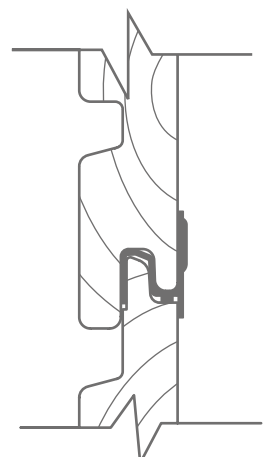

C8D

# 6. Corner designs

## CP3 CORNER PROFILE FOR EXTERNAL AND INTERNAL CORNERS

One universal profile for external and internal corners.

Boards with straight-cut ends can be installed without exposing the end-grain.

 The easiest option for a seamless transition from wall to wall.

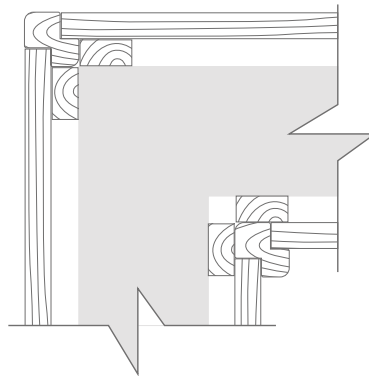

Corner profile CP3

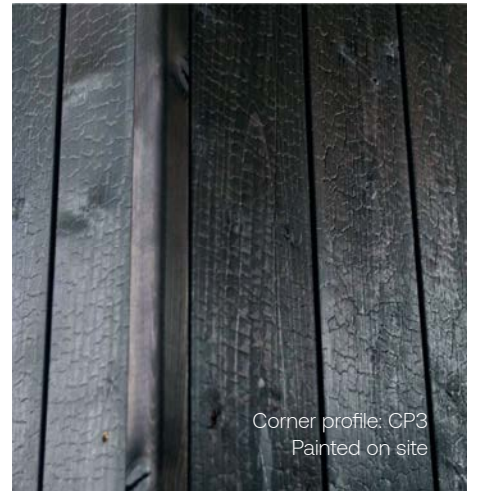

### SOME OTHER CORNER SOLUTIONS:

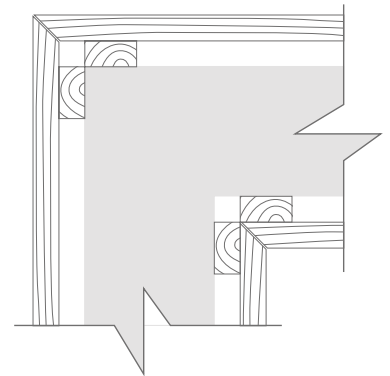

Cut the boards to a 45-degree angle.

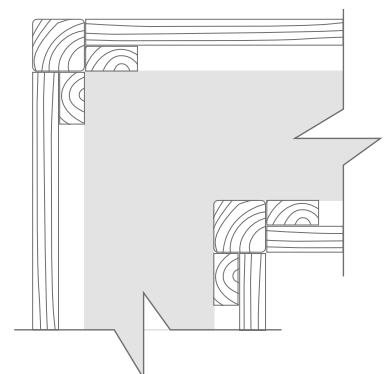

Use C4 42 x 42 mm profile.

# 7. Installing pre-finished Thermory cladding

1. Make sure that all boards installed on a surface are from the same bundle or batch number.
2. Board ends and any dents must be painted over during installation, otherwise moisture can penetrate the wood, causing the board to cup and paint on the visible side to crack.
3. Leave the protective foils between painted boards when restacking. Where possible, leave the boards in their original packaging for the duration of storage and do not remove the shrink wrap until just before installation.
4. Do not keep unpacked products in a dusty environment.
5. Take care when restacking brushed products. Always place the boards with the brushed sides facing each other; otherwise, the separating sticks may produce visible marks.
6. Use sufficient lighting throughout the installation process to help you notice any color discrepancies or defects.
7. Slight color and gloss variations may occur between display samples, individual boards and deliveries, or even within individual boards, due to natural variations in the timber or the effects of aging on the paint.
8. Be mindful about installing boards with too much color contrast alongside each other. Sometimes boards with slightly different tones should be distributed evenly rather than being installed adjacent to each other, even if they all fall within the acceptable range.
9. Allow for 10 percent wastage when purchasing.
10. Check the boards thoroughly for possible transport-related damage prior to installation, and never install defective boards. **ONCE INSTALLED, PRODUCTS ARE DEEMED TO HAVE BEEN ACCEPTED IN TERMS OF QUALITY.**



Vivid by Thermory thermo-spruce cladding (D4 / Channelsiding), color Black.  
Private house in Netherlands.  
Distribution & Photo by InterFaca

## 8. Surface maintenance



Please follow the [Thermory Cladding Maintenance Guide](#) for more detailed tips.

Natural uncoated thermally modified wood does not require any special care other than cleaning. Thermory's thermally modified cladding boards are durable and remain weatherproof for decades, even in the most demanding climates.

### WHEN USING THERMORY CLADDING OUTDOORS, THE SURFACE OF THE BOARDS WILL NATURALLY TURN GRAY OVER TIME, JUST LIKE ANY OTHER WOOD PRODUCT

This process begins immediately after the products are installed and can take anything from a few months to several years depending on the intensity of UV radiation they're subjected to.

### FOR THERMORY COATED AND OILED CLADDING, MAINTENANCE PAINTING REQUIREMENTS ARE BASED ON THE SPECIFIC PRODUCT

**THERMORY VIVID SILVERED** – we recommend leaving Vivid Silvered cladding to weather naturally rather than repainting it

**THERMORY VIVID OPAQUE** – the expected service lifetime of the opaque paint is 10 to 15 years, depending on the paint type

**THERMORY VIVID TRANSLUCENT** – the expected service lifetime of the semi-transparent paint is 7 years

**IGNITE BY THERMORY** – the expected service lifetime of the semi-transparent black paint is 5 years, and 7 years for the opaque black paint

**THERMORY OILED CLADDING BOARDS** – the expected service lifetime of the oil is 1-3 years, depending on weather conditions and the building's location



Keep in mind that wood is a natural material and so any color changes may be uneven. Each board ages in its own way, and different sides of a building's facade will also age differently depending on the sun and rain they're exposed to. Sapwood will generally turn darker faster than heartwood.



Thermory cladding boards can be protected with a coat of UV-resistant pigmented finish such as a wax, stain, paint or mineral oil to reduce discoloration or freshen up their appearance. Natural linseed-based oils are not recommended, as they contain substances that provide a food source for biological organisms such as bacteria, mold, etc.



Oil and paint should only be applied to clean, dust-free surfaces. Before using a tinted finishing product, mix it thoroughly and test the suitability of the shade on a small area. Always follow the application instructions provided by the manufacturer as application and drying times can vary.



When using Benchmark by Thermory thermo-radiata pine cladding for exteriors, we recommend applying a finish on all four sides of the board with a UV-resistant surface-sealing oil or paint prior to outdoor installation, with the finish regularly reapplied before it wears off. You can also leave your thermo-radiata pine cladding uncoated, but dust and other airborne particles are more likely to adhere to the porous surface of the natural wood.



Thermory pre-finished cladding will retain its qualities for longer if installed under sufficient roof overhangs and proper guttering to minimize contact with water

### CLEANING THERMALLY MODIFIED WOOD



Thermally modified wood can be washed with a wood cleaner and warm water. Before applying the wood cleaner, thoroughly clean the boards with a brush to remove any dirt and debris.



For rinsing, it's a good idea to use a garden hose with a spray nozzle on a low-pressure setting, and test it on a small area beforehand. A strong jet of water can damage the wood, resulting in an uneven appearance.



Before carrying out any maintenance painting, remove any loose paint, dust or other dirt from the wooden façade using water and a scrubbing brush. The façade surface must be clean and dry before applying the finish.



# Leave a lasting impact

THERMORY is a world leader in the thermal modification of wood. We offer high-quality, long-lasting solutions that benefit from environmentally friendly technology. We have spent the past two decades developing our expertise through close collaboration with architects, designers, builders and homeowners – constantly revising our product selection and refining our technology in the process.

THERMORY promotes a transparent and responsible corporate culture. We care about the environment and treat nature with deep respect. Our purchasing process is environmentally responsible, and we exercise high standards for quality and sustainability. Our timber is carefully inspected and harvested from sustainably managed forests.

- DECKING
- CLADDING
- INTERIOR
- SAUNA

If desired, we can offer PEFC, FSC or Nordic Swan Ecolabel-certified wood.



As a renewable resource that is both durable and an excellent insulator, wood is one of the most environmentally friendly choices for your construction projects. If you think it's important to protect our valuable resources long into the future, then we're on the same mission. We create lasting value, because we want to leave behind a more harmonious and sustainable world.

## REAL WOOD PRODUCTS WITH BEAUTY AND STABILITY IN EVERY FIBER